

# Silicon Phototransistor

## OP580



### Features:

- Wide acceptance angle
- Fast response time
- Plastic leadless chip carrier (PLCC)

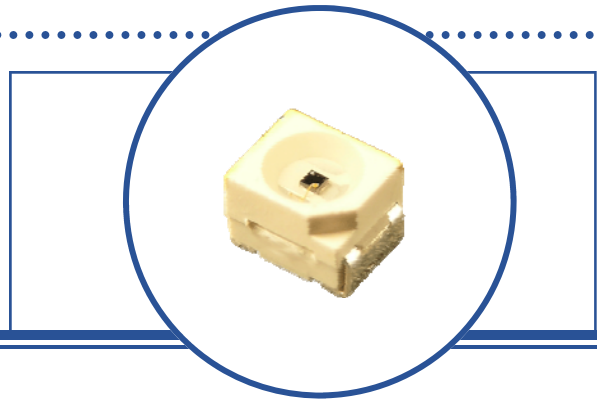

### Description:

The **OP580** is an NPN silicon phototransistor mounted in a miniature SMD package. The device has a flat window lens, which enables a wide acceptance angle. It is packaged in a plastic leadless chip carrier that is compatible with most automated mounting equipment. *The OP580 is mechanically and spectrally matched to the OP280 infrared LED.*

*Please refer to Application Bulletins 208 and 210 for additional design information and reliability (degradation) data.*

### Applications:

- Non-contact position sensing
- Datum detection
- Machine automation
- Optical encoders

Ordering Information			
Part Number	Sensor	Viewing Angle	Lead Length
OP580	Phototransistor	100°	N/A

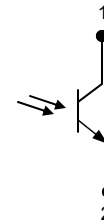
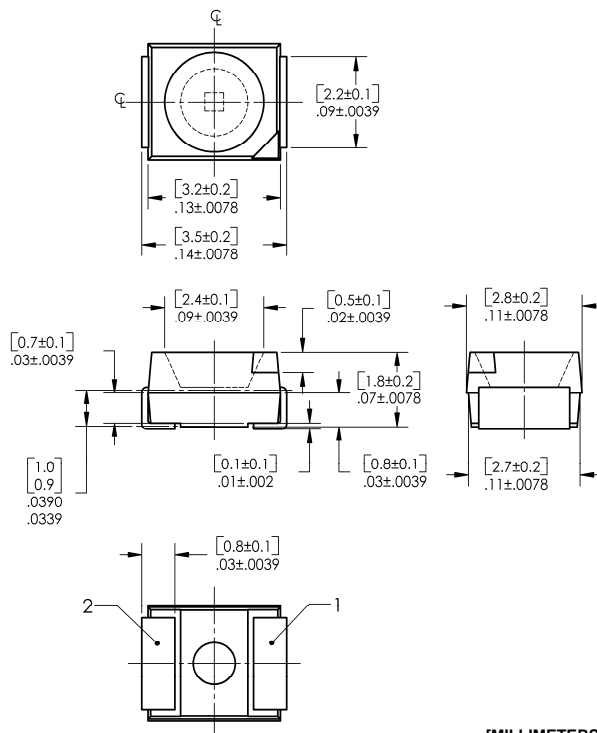

Pin #	Transistor
1	Collector
2	Emitter



RoHS

OPTEK reserves the right to make changes at any time in order to improve design and to supply the best product possible.

**Absolute Maximum Ratings** ( $T_A=25^\circ\text{C}$  unless otherwise noted)

Storage Temperature Range	-40° C to +85° C
Operating Temperature Range	-25° C to +85° C
Lead Soldering Temperature	260° C <sup>(1)</sup>
Collector-Emitter Voltage	30 V
Emitter-Collector Voltage	5 V
Collector Current	20 mA
Power Dissipation	75 mW <sup>(2)</sup>

**Electrical Characteristics** ( $T_A = 25^\circ\text{C}$  unless otherwise noted)

SYMBOL	PARAMETER	MIN	TYP	MAX	UNITS	TEST CONDITIONS
$I_{C(ON)}$	On-State Collector Current	1.0	-	-	mA	$V_{CE} = 5.0\text{ V}, E_E = 5.0\text{ mW/cm}^2$ <sup>(3)</sup>
$V_{CE(SAT)}$	Collector-Emitter Saturation Voltage	-	-	0.4	V	$I_C = 100\ \mu\text{A}, E_E = 2.0\text{ mW/cm}^2$ <sup>(3)</sup>
$I_{CE0}$	Collector-Emitter Dark Current	-	-	100	nA	$V_{CE} = 5.0\text{ V}, E_E = 0$ <sup>(4)</sup>
$V_{(BR)CEO}$	Collector-Emitter Breakdown Voltage	30	-	-	V	$I_C = 100\ \mu\text{A}$
$V_{(BR)ECO}$	Emitter-Collector Breakdown Voltage	5	-	-	V	$I_E = 100\ \mu\text{A}$
$t_r, t_f$	Rise Time , Fall Time	-	15	-	$\mu\text{s}$	$I_C = 1\text{ mA}, R_L = 1\text{ K}\Omega$

Notes:

- Solder time less than 5 seconds at temperature extreme.
- Derate linearly at 2.17 mW/° C above 25° C.
- $E_{E(APT)}$  is an unfiltered GaAs LED with a peak emission wavelength of 935 nm and a radiometric intensity level which varies less than 10% over the entire lens surface of the phototransistor being tested.
- To calculate typical collector dark current in  $\mu\text{A}$ , use the formula  $I_{CE0} = 10^{(0.04 T_a - 3.4)}$  where  $T_a$  is the ambient temperature in ° C.

**Relative Response vs Wavelength**

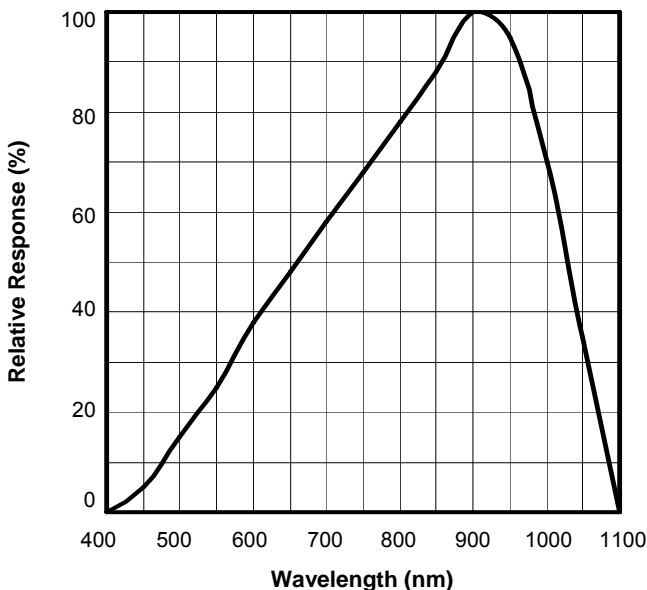

**Relative Response vs Angular Position**

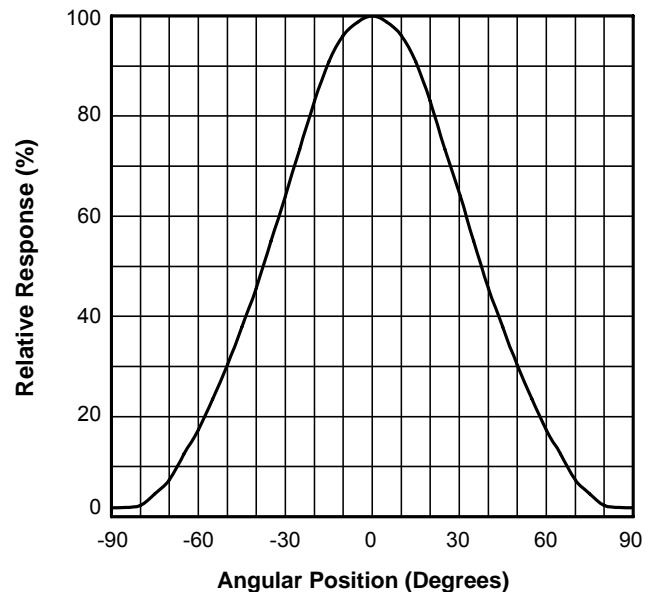

OPTEK reserves the right to make changes at any time in order to improve design and to supply the best product possible.

**Relative On-State Collector Current vs Irradiance**

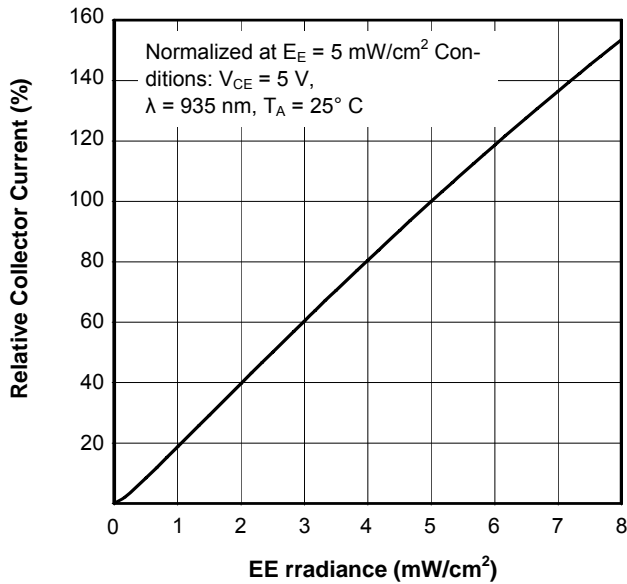

**Relative On-State Collector Current vs Temperature**

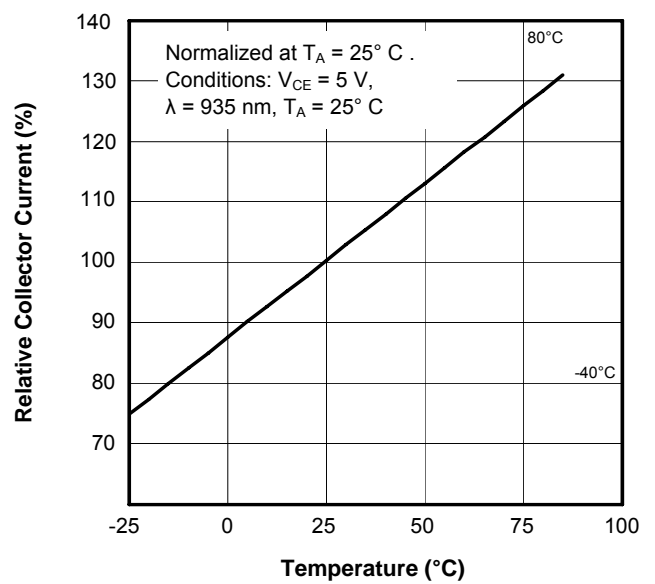

**Collector-Emitter Dark Current vs Temperature**

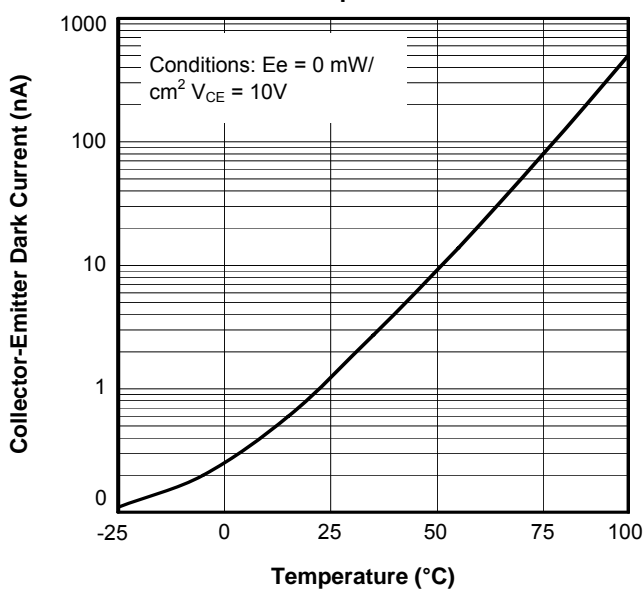

**Relative On-State Collector Current vs Collector-Emitter Voltage**

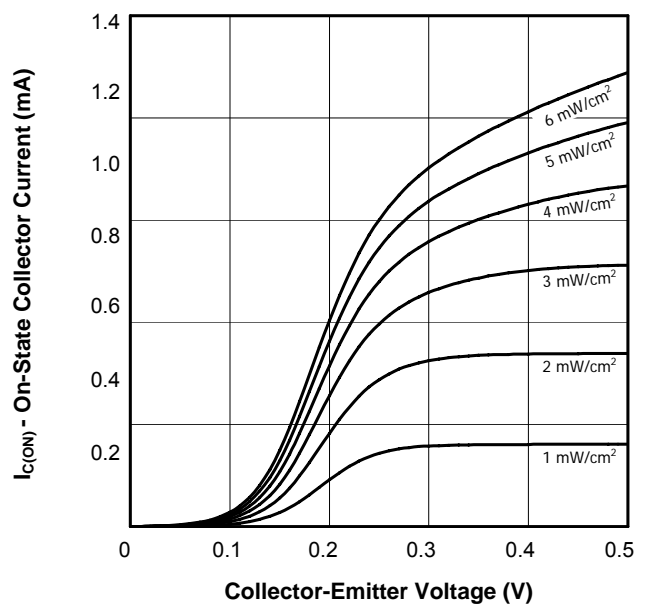

OPTeK reserves the right to make changes at any time in order to improve design and to supply the best product possible.